

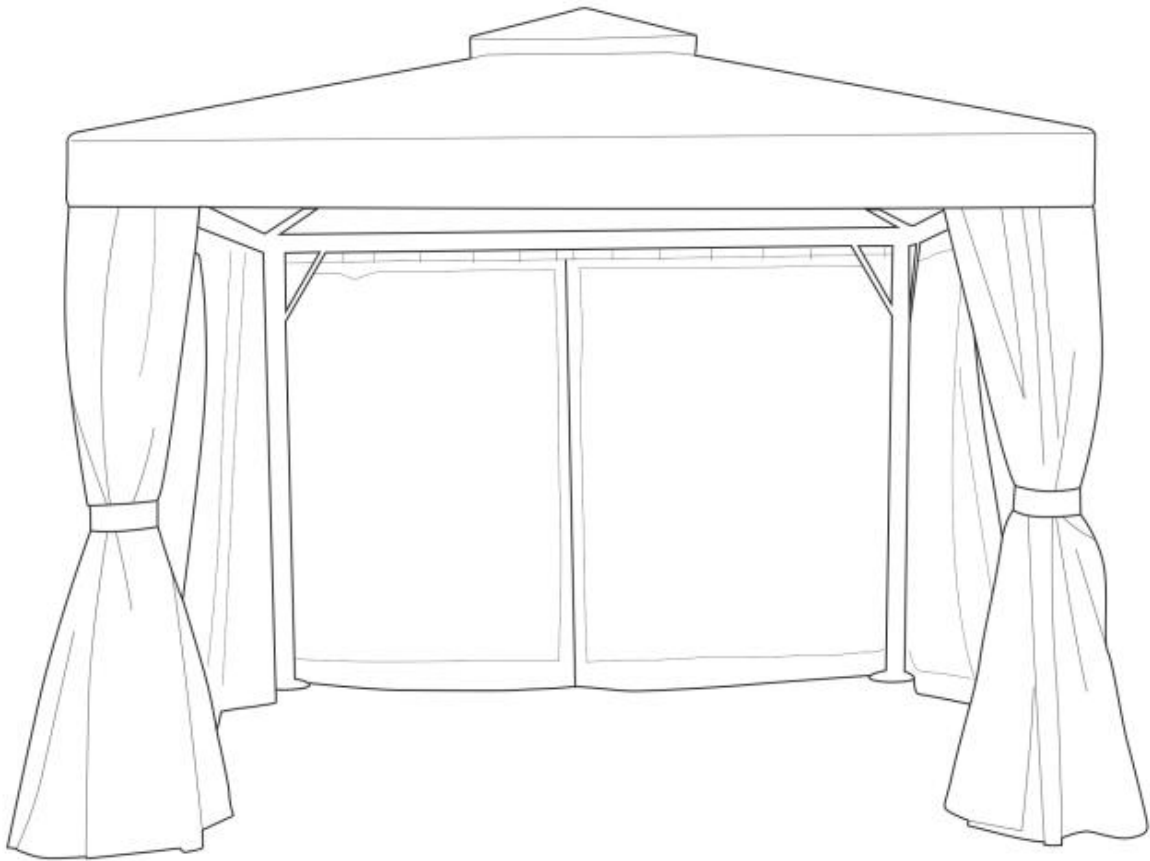









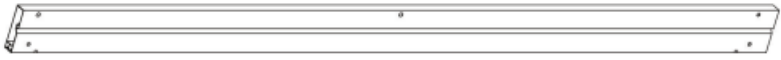











3x3



Parts

| | | | | | | | | |
|---|--|----|---|--|----|---|--|-----|
| A |  | | | 4 | | | | |
| B |  | | | 4 | | | | |
| C |  | | | 4 | | | | |
| D |  | | | 4 | | | | |
| E |  | | | 4 | | | | |
| I |  | 4 | F |  | 4 | G |  | 8 |
| L |  | 1 | J |  | 1 | R |  | 112 |
| Q |  M6*12 | 56 | N |  M6*25 | 8 | P |  M6*40 | 16 |
| O |  | 4 | Z |  | 16 | K |  | 12 |
| S |  | 1 | T |  | 1 | | | |
| U |  | 4 | w |  | 4 | | | |

Step 1

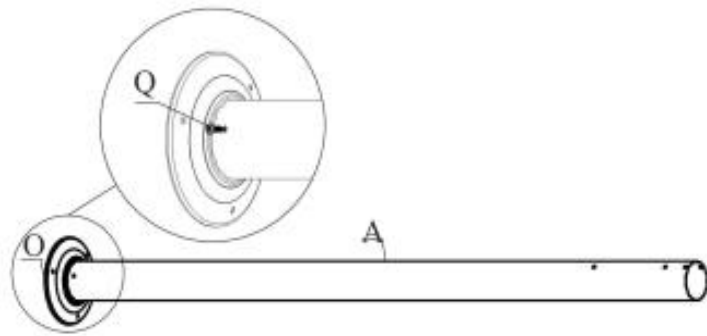

Step 2

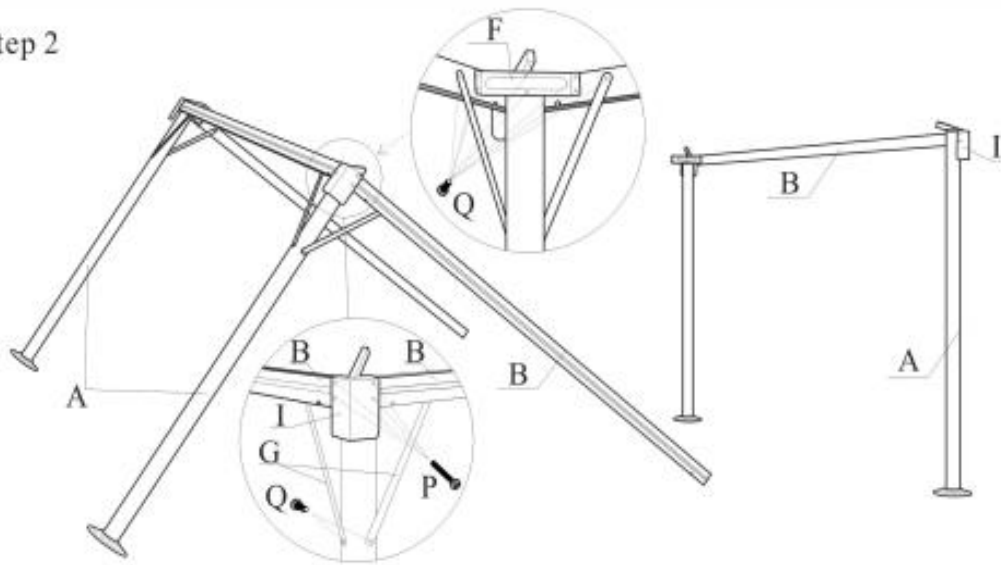

Step 3

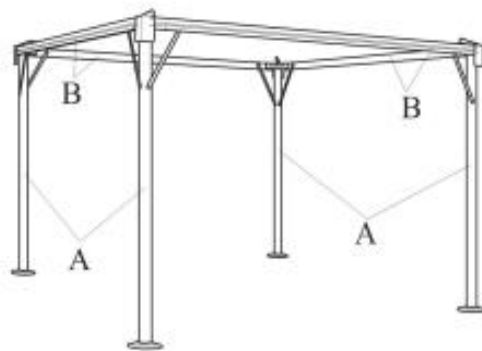

Step 4

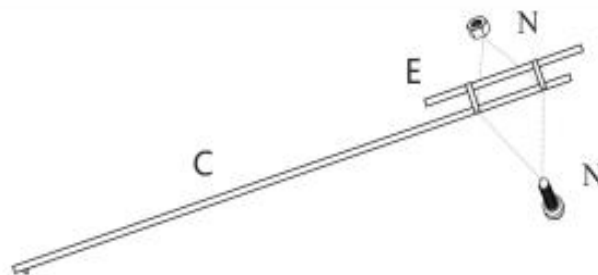

Step 5

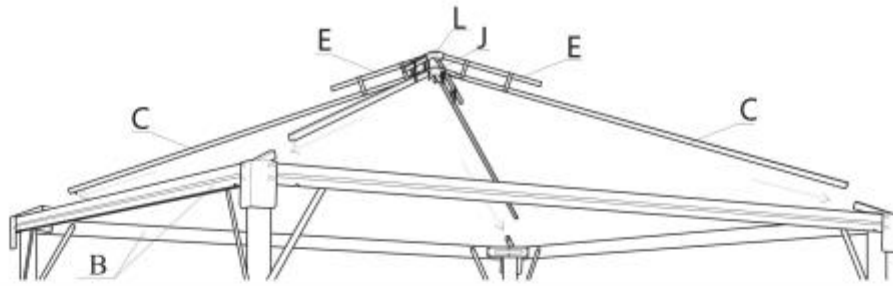

Step 6

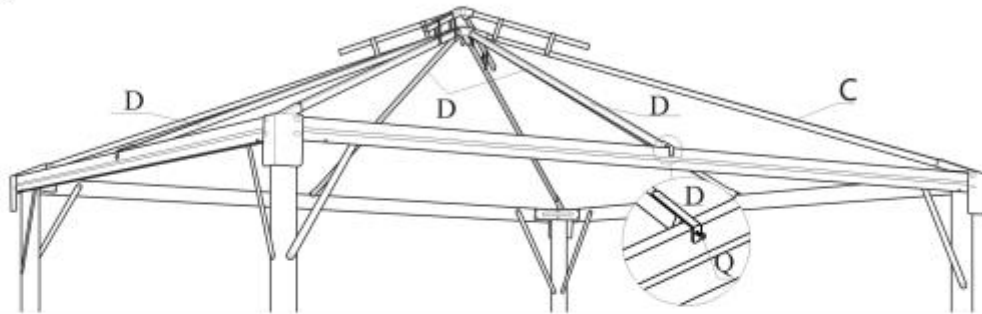

Step 7

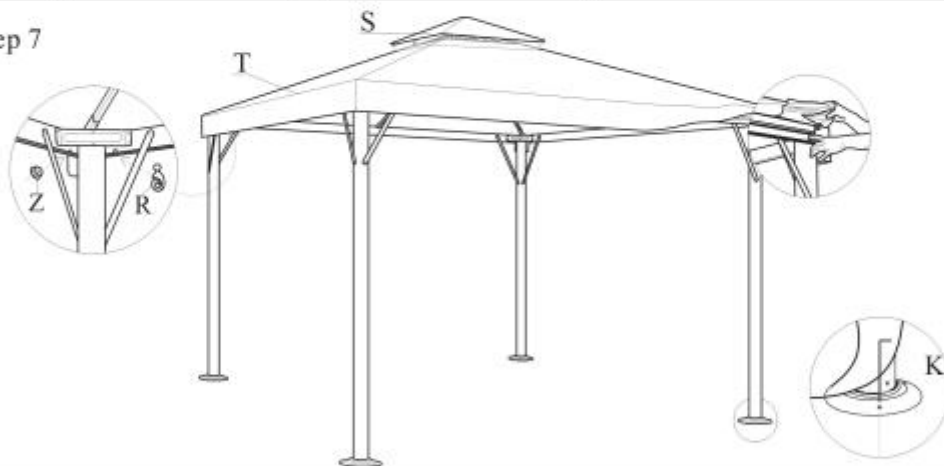

Step 8

