

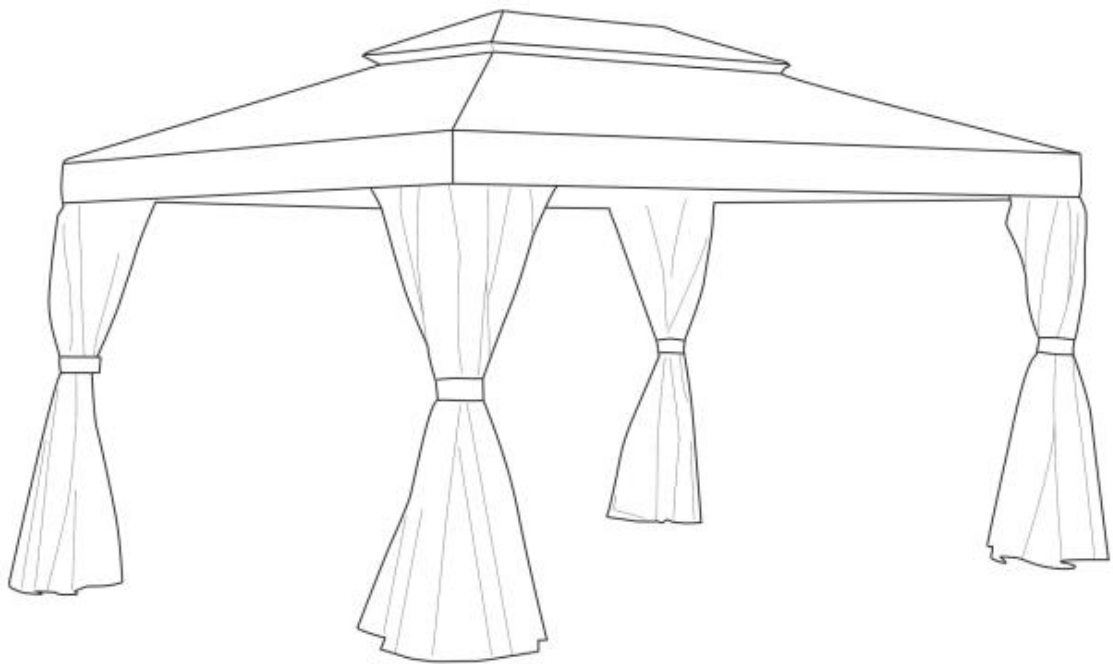

























3x4



Parts

A			4					
B			2					
E			2					
C			4					
D			4					
H			4					
G			1					
J			1					
I		4	F		4	L		8
M		2	X		2	V		1
Q	 M6*12	56	N	 M6*25	6	P	 M6*40	16
O		4	S		1	T		1
Z		16	R		128			
U		4	w		4	K		12

Step 1

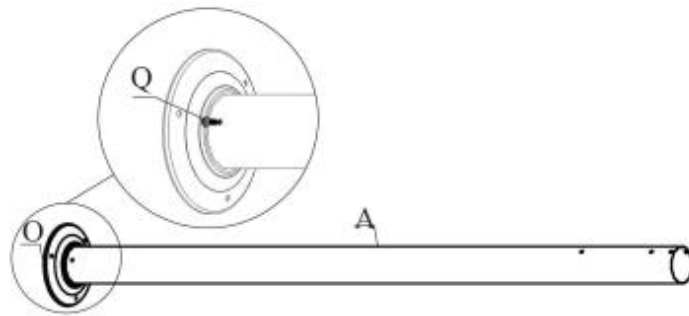

Step 2

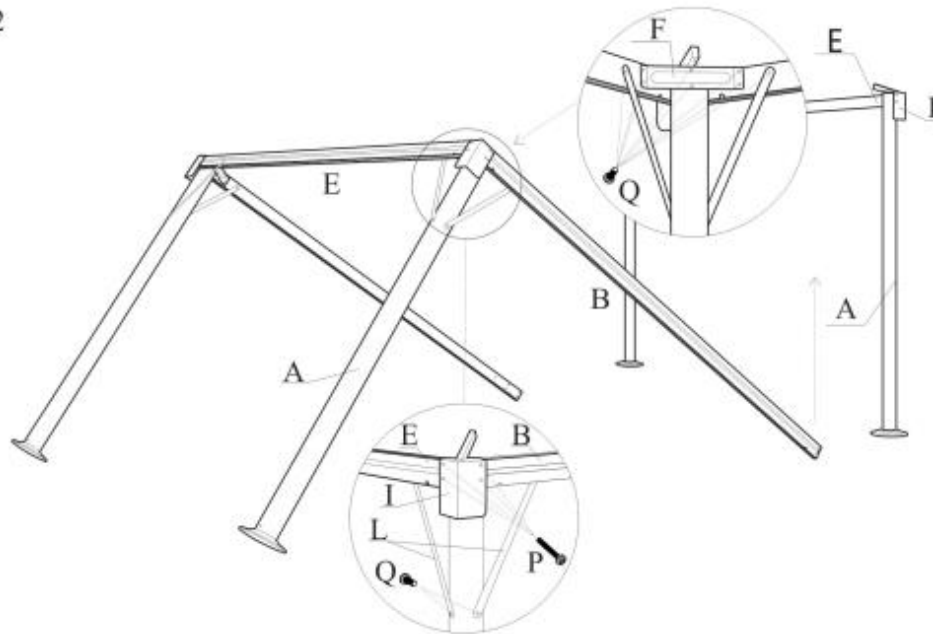

Step 3

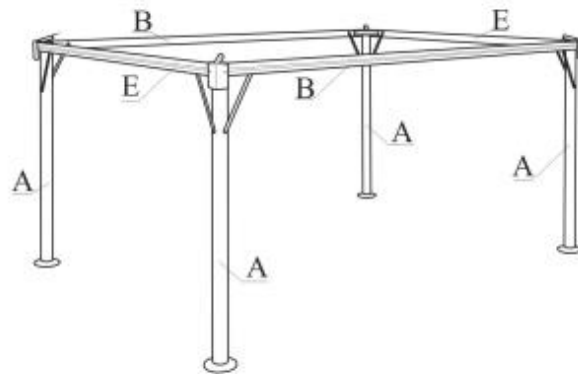

Step 4

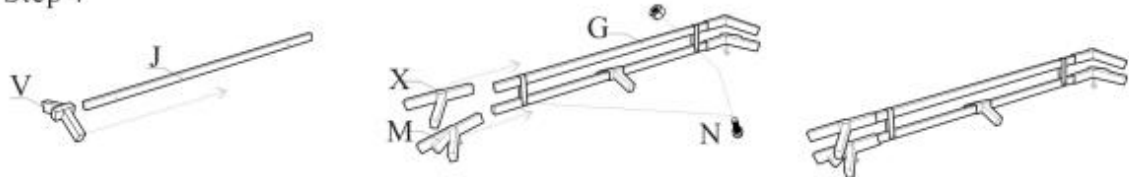

Step 5

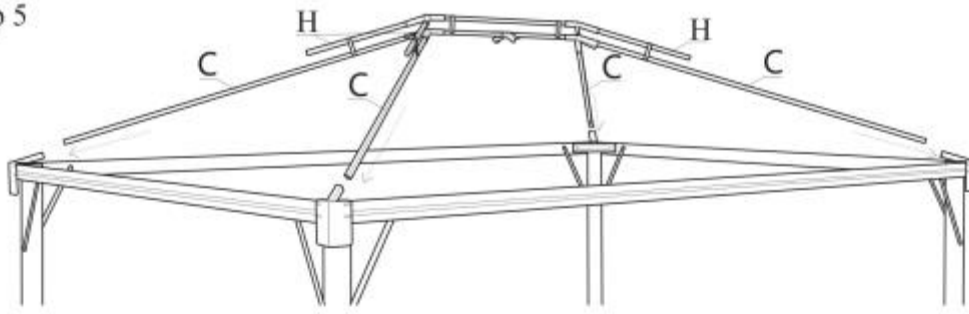

Step 6

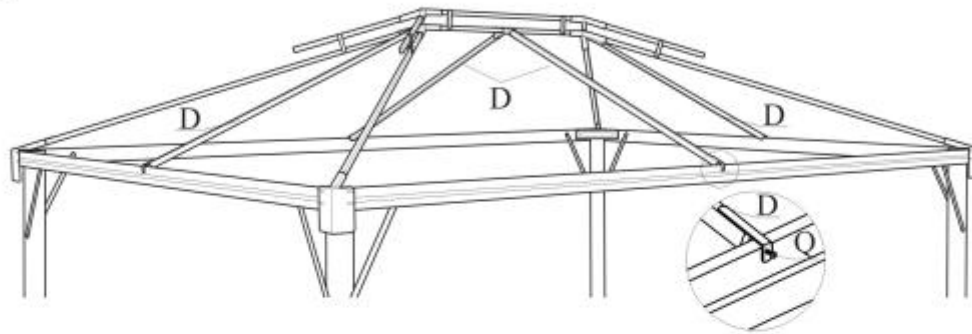

Step 7

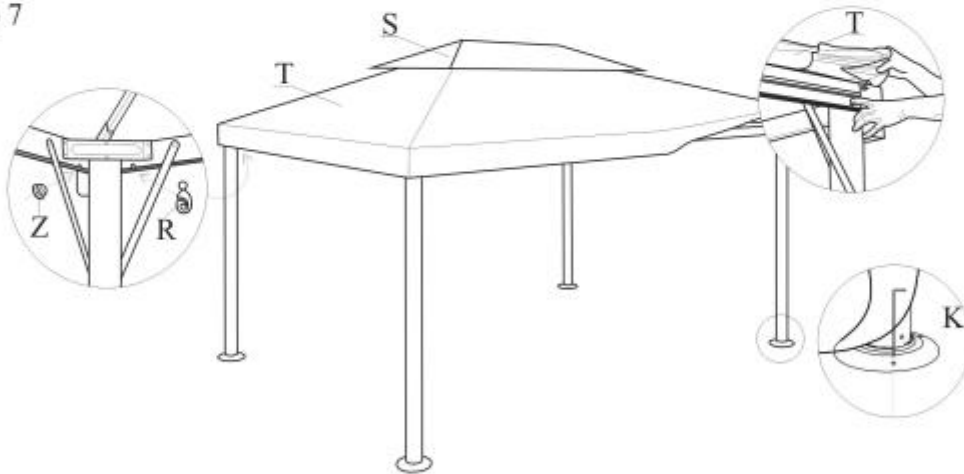

Step 8

